

## Description

The AU0521P1L is a bi-directional TVS diode, utilizing leading monolithic silicon technology to provide fast response time and low ESD clamping voltage, making this device an ideal solution for protecting voltage sensitive data and power line. The AU0521P1L complies with the IEC 61000-4-2 (ESD) with  $\pm 30$  kV air and  $\pm 30$  kV contact discharge. It is assembled into an ultra-small 1.0x0.6x0.5mm lead-free DFN package. The small size and high ESD surge protection make AU0521P1L an ideal choice to protect cell phone, digital cameras, audio players and many other portable applications.

## Features

- Ultra small package: 1.0x0.6x0.5mm
- Protects one data or power line
- Ultra low leakage: nA level
- Low operating voltage: 5V
- Low clamping voltage
- 2-pin leadless package
- Complies with following standards:
  - IEC 61000-4-2 (ESD) immunity test  
Air discharge:  $\pm 30$  kV  
Contact discharge:  $\pm 30$  kV
  - IEC61000-4-5 (Lightning) 6A (8/20 $\mu$ s)
- RoHS Compliant

## Mechanical Characteristics

- Package: DFN1006-2 (1.0x0.6x0.5mm)
- Case Material: “Green” Molding Compound.
- Terminal Connections: See Diagram Below
- Marking Information: See Below

## Applications

- Cellular Handsets and Accessories
- Personal Digital Assistants
- Notebooks and Handhelds
- Portable Instrumentation
- Digital Cameras
- Peripherals
- Audio Players
- Keypads, Side Keys, LCD Displays

## Marking Information

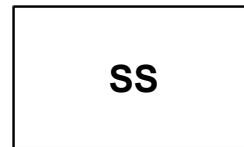

SS = Device Marking Code

## Dimensions and Pin Configuration

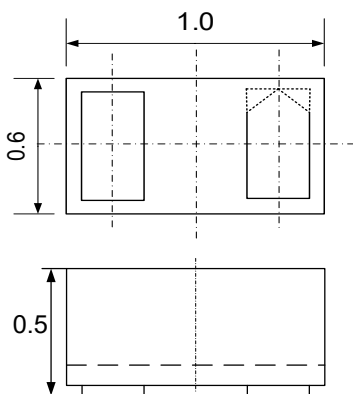

Package Dimensions

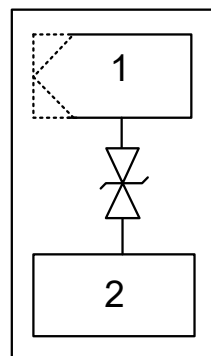

Circuit and Pin Schematic

## Ordering Information

Part Number	Packaging	Reel Size
AU0521P1L	10000/Tape & Reel	7 inch

**Absolute Maximum Ratings (T<sub>A</sub>=25°C unless otherwise specified)**

Parameter	Symbol	Value	Unit
Peak Pulse Power (8/20μs)	Ppk	70	W
Peak Pulse Current (8/20μs)	I <sub>PP</sub>	6	A
ESD per IEC 61000-4-2 (Air) ESD per IEC 61000-4-2 (Contact)	V <sub>ESD</sub>	±30 ±30	kV
Operating Temperature Range	T <sub>J</sub>	-55 to +125	°C
Storage Temperature Range	T <sub>stg</sub>	-55 to +150	°C

**Electrical Characteristics (T<sub>A</sub>=25°C unless otherwise specified)**

Parameter	Symbol	Min	Typ	Max	Unit	Test Condition
Reverse Working Voltage	V <sub>RWM</sub>			5	V	
Breakdown Voltage	V <sub>BR</sub>	6		8	V	I <sub>T</sub> = 1mA
Reverse Leakage Current	I <sub>R</sub>			0.2	μA	V <sub>RWM</sub> = 5V
Clamping Voltage	V <sub>C</sub>			8	V	I <sub>PP</sub> = 1A
Clamping Voltage	V <sub>C</sub>			11.7	V	I <sub>PP</sub> = 6A
Junction Capacitance	C <sub>J</sub>		9		pF	V <sub>R</sub> = 0V, f = 1MHz

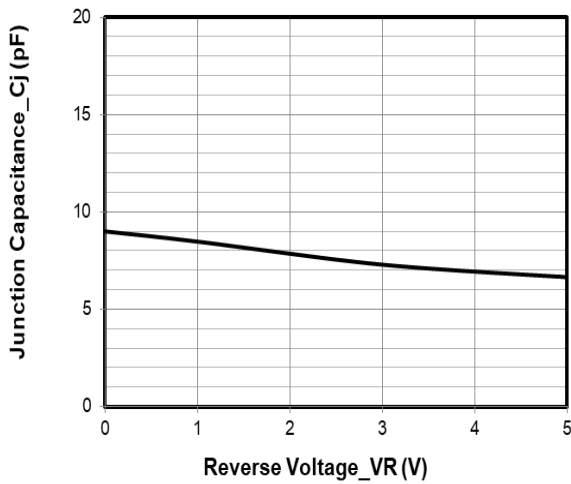
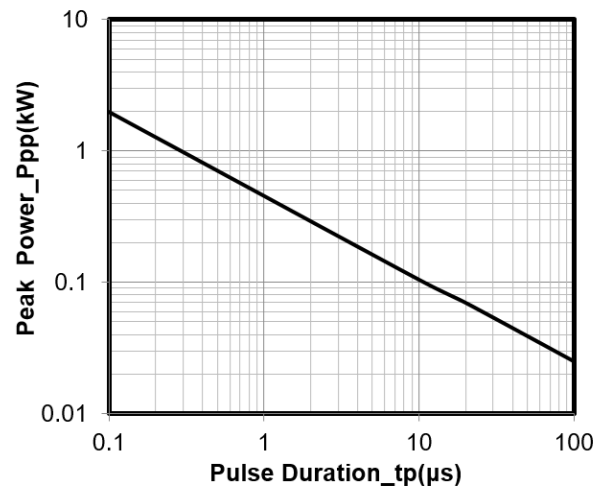
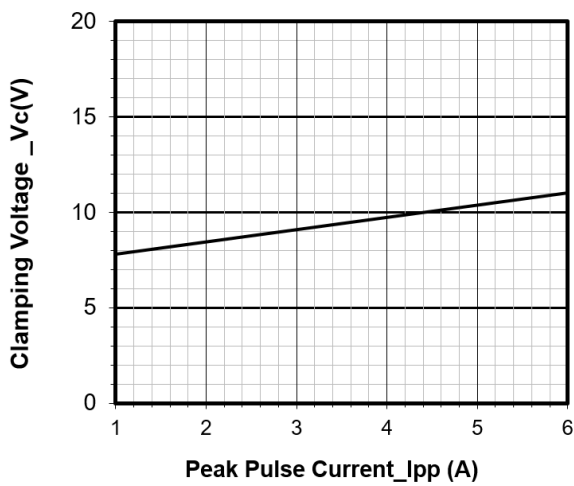
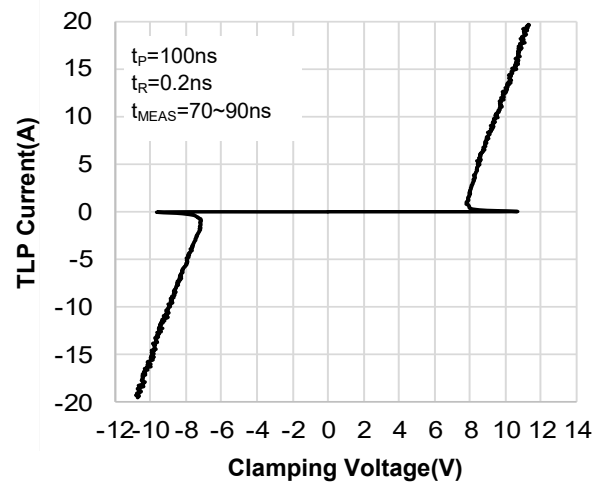
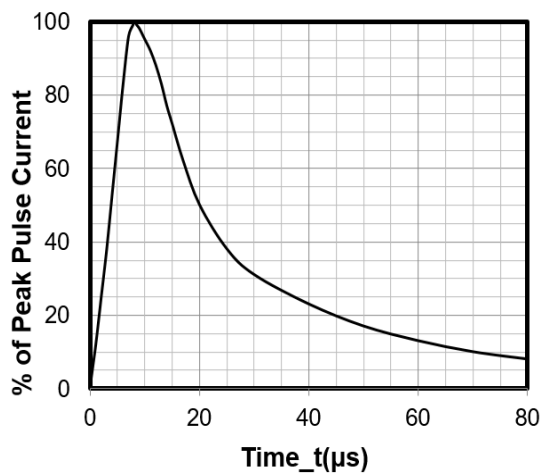
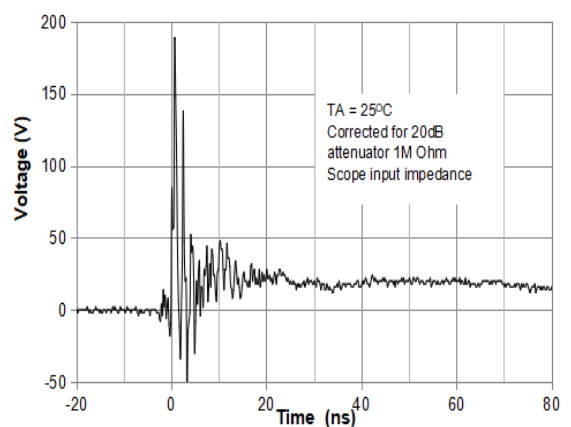
**Typical Performance Characteristics ( $T_A=25^\circ\text{C}$  unless otherwise Specified)**

**Junction Capacitance vs. Reverse Voltage**

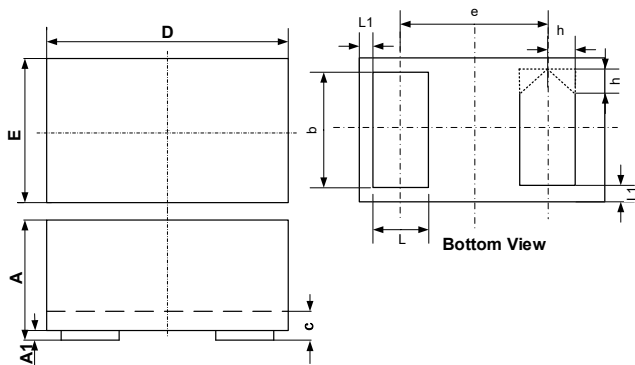
**Peak Pulse Power vs. Pulse Time**

**Clamping Voltage vs. Peak Pulse Current ( $t_p = 8/20\mu\text{s}$ )**

**TLP Curve**

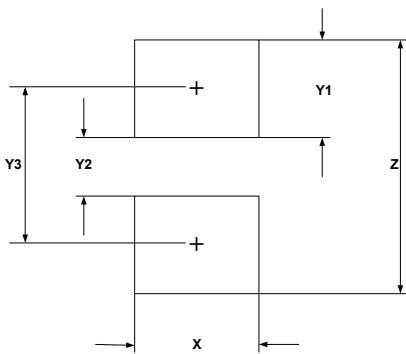
**8 X  $20\mu\text{s}$  Pulse Waveform**

**ESD Clamping Voltage**
**8 kV Contact per IEC61000-4-2**

### DFN1006-2 Package Outline Drawing



SYM	DIMENSIONS					
	MILLIMETERS			INCHES		
	MIN	NOM	MAX	MIN	NOM	MAX
A	0.45	0.50	0.55	0.018	0.020	0.022
A1	0.00	0.02	0.05	0.000	0.001	0.002
b	0.45	0.50	0.55	0.018	0.020	0.022
c	0.12	0.15	0.18	0.005	0.006	0.007
D	0.95	1.00	1.05	0.037	0.039	0.041
e	0.65 BSC			0.026 BSC		
E	0.55	0.60	0.65	0.022	0.024	0.026
L	0.20	0.25	0.30	0.008	0.010	0.012
L1	0.05REF			0.002REF		
h	0.07	0.12	0.17	0.003	0.005	0.007

### Suggested Land Pattern



SYM	DIMENSIONS	
	MILLIMETERS	INCHES
X	0.60	0.024
Y1	0.50	0.020
Y2	0.30	0.012
Y3	0.80	0.032
Z	1.30	0.052

### Contact Information

Applied Power Microelectronics Inc.

Website: <http://www.appliedpowermicro.com>

Email: [sales@appliedpowermicro.com](mailto:sales@appliedpowermicro.com)

Phone: +86 (0519) 8399 3606